

Cabinet Knob & Pull Collections



The Finishing Touch That
Makes A Statement



JEFFREY ALEXANDER®
by Hardware Resources

E L E M E N T S®
by Hardware Resources

JEFFREY ALEXANDER®

by Hardware Resources

ELEMENTS®

by Hardware Resources

Aberdeen.....	6	Key West & Key Largo ..	36-37
Alvar	4-5	Lafayette	38
Annadale	7	LLexa.....	39
Anwick	8-9	Leyton.....	40-41
Belcastel 1	10-11	Lyon.....	42
Boswell.....	12-13	Marlo.....	43
Bremen 1.....	14-15	Merrick.....	44-45
Bremen 2.....	16	Milan 1	46
Cairo	17	Mirada.....	47
Callie	18-19	Philip NEW	48-49
Cordova	20	PRae.....	50
Delgado	21	Regan	51
Delmar	22	Roman NEW	52-53
Dominique NEW	24-25	Royce.....	54
Durham	23	Sonoma	55
Elara.....	26-27	Sullivan.....	56-57
Ella	28	Sutton.....	58
Harlow	29	Tahoe.....	59
Hayworth.....	30-31	Tiffany.....	60-61
Hudson.....	32	Wheeler NEW	62-63
Katharine.....	33	Zane.....	64
Key Grande	34-35		

Aiden.....	68-69
Asher.....	67
Belfast.....	70
Brenton.....	71
Calloway.....	72
Cosgrove	73
Edgefield	74
Florence.....	75
Glendale.....	78
Hadly NEW OPTIONS	76-77
Kenner	79
Knox NEW	80-81
Lindos.....	82
Madison.....	83
Merryville.....	84
Naples.....	86-88
Park	85
Seaver.....	89
Sedona	90
Slade	91
Stanton.....	92-93
Strickland.....	94
Thatcher NEW	96-97
Watervale.....	95
Westbury.....	98
Zachary.....	99

This catalog features a selection of our Jeffrey Alexander and Elements knob and pull collections. Please visit www.hardwareresources.com for our complete offering.

Each Jeffrey Alexander and Elements item in this catalog has been marked with a letter code. The letter by each item corresponds to a price range for that item's suggested retail price. For the exact price on any item, please visit www.hardwareresources.com or reference your current price list.

Label	Price Range
[A]	Under \$3.25
[B]	~\$3.25 – \$4.25
[C]	~\$4.25 – \$5.50
[D]	~\$5.50 – \$7.75
[E]	~\$7.75 – \$9.75
[F]	~\$9.75 – \$13.00
[G]	~\$13.00 – \$16.25
[H]	~\$16.25 – \$21.50
[J]	~\$21.50 – \$27.00
[K]	See Sales Associate



A STEP ABOVE...

IN QUALITY, SELECTION, & DESIGN

Design Details

50+ Patented and original collections plus industry standard designs in a wide variety of styles including Traditional, Transitional and Modern/Contemporary.

Heavier in Weight

Our designs have solid or flat backs, providing a comfortable feel in your hand.

Made from Quality Materials

Zinc/Zamak Alloy – A Zinc alloy that contains approximately 4% aluminum which provides excellent die castability and strength, resulting in a durable, corrosion-resistant product. Zinc is also a clean and recyclable material, making it eco-friendly.

Steel – durable and resistant to corrosion, providing a superior product.

Lifetime Warranty

Hardware Resources believes in quality, integrity and reliability by offering a lifetime warranty on all of our Jeffrey Alexander decorative hardware).

JEFFREY ALEXANDER®

by Hardware Resources



JEFFREY ALEXANDER®

by Hardware Resources



ALVAR

Item	Description	Overall Length or Diameter	Ctn Qty	Finishes	Price Code
264-3	3" CC	3-11/16"	20	BNBDL, DBAC, NI, PC, SBZ, SN	[D]
264-96	96 mm (3-3/4") CC	4-7/16"	20	BNBDL, DBAC, NI, PC, SBZ, SN	[E]
264-128	128 mm (5-1/16") CC	5-3/4"	20	BNBDL, DBAC, NI, PC, SBZ, SN	[E]
264-160	160 mm (6-5/16") CC	7"	10	BNBDL, DBAC, NI, PC, SBZ, SN	[F]
264-192	192 mm (7-9/16") CC	8-1/4"	10	BNBDL, DBAC, NI, PC, SBZ, SN	[G]

Finishes



BNBDL
Brushed
Pewter



DBAC
Brushed Oil
Rubbed Bronze



NI
Polished Nickel



PC
Polished
Chrome



SBZ
Satin Bronze



SN
Satin Nickel

JEFFREY ALEXANDER®

by Hardware Resources



ABERDEEN

US Patent # D708,927; D707,098; D722,483; D710,674

Item	Description	Overall Length or Diameter	Ctn Qty	Finishes	Price Code
535	square knob	1-1/4"	20	BNB, BNBDL, DBAC, SN	[F]
535L	oblong knob	1-1/2"	20	BNB, BNBDL, DBAC, SN	[F]
535-96	96 mm (3-3/4") CC	5"	10	BNB, BNBDL, DBAC, SN	[H]
536-96	96 mm (3-3/4") CC cup pull	5"	10	BNB, BNBDL, DBAC, SN	[H]
535-128	128 mm (5-1/16") CC	6-1/4"	10	BNB, BNBDL, DBAC, SN	[J]
536-128	128 mm (5-1/16") CC cup pull	6-1/4"	10	BNB, BNBDL, DBAC, SN	[K]
535-160	160 mm (6-5/16") CC	7-5/8"	10	BNB, BNBDL, DBAC, SN	[K]

Finishes



BNB

Brushed Black Nickel



BNBDL

Brushed Pewter



DBAC

Brushed Oil
Rubbed Bronze



SN

Satin Nickel

JEFFREY ALEXANDER®

by Hardware Resources



ANNADALE

US Patent # D708,040; D708,926; D721,941; D711,722

Item	Description	Overall Length or Diameter	Ctn Qty	Finishes	Price Code
435	square knob	1-1/4"	20	BNBDL, DACM, DBAC, MB, SN	[F]
435L	oblong knob	1-1/2"	20	BNBDL, DACM, DBAC, MB, SN	[F]
435-96	96 mm (3-3/4") CC	5"	10	BNBDL, DACM, DBAC, MB, SN	[G]
436-96	96 mm (3-3/4") CC cup pull	5"	10	BNBDL, DACM, DBAC, MB, SN	[H]
435-128	128 mm (5-1/16") CC	6-1/4"	10	BNBDL, DACM, DBAC, MB, SN	[J]
436-128	128 mm (5-1/16") CC cup pull	6-1/4"	10	BNBDL, DACM, DBAC, MB, SN	[K]
435-160	160 mm (6-5/16") CC	7-5/8"	10	BNBDL, DACM, DBAC, MB, SN	[K]

Finishes



BNBDL
Brushed Pewter



DACM
Gun Metal



DBAC
Brushed Oil
Rubbed Bronze



MB
Matte Black



SN
Satin Nickel

JEFFREY ALEXANDER®

by Hardware Resources



ANWICK

US Patent # D728,342; D737,654

Item	Description	Overall Length or Diameter	Ctn Qty	Finishes	Price Code
867	oblong knob	1-3/8"	30	BNBDL, DBAC, NI, SN	[E]
867L	square knob	1-1/8"	20	BNBDL, DBAC, NI, SN	[E]
867-3	3" CC	4-5/16"	10	BNBDL, DBAC, NI, SN	[F]
867-96	96 mm (3-3/4") CC	5-1/8"	10	BNBDL, DBAC, NI, SN	[G]
867-128	128 mm (5-1/16") CC	6-3/8"	10	BNBDL, DBAC, NI, SN	[H]
867-160	160 mm (6-5/16") CC	7-5/8"	10	BNBDL, DBAC, NI, SN	[J]
867-228	228 mm (9") CC	10-5/16"	10	BNBDL, DBAC, NI, SN	[K]
867-320	320 mm (12-5/8") CC	13-15/16"	10	BNBDL, DBAC, NI, SN	[K]

Finishes



BNBDL
Brushed Pewter



DBAC
Brushed Oil
Rubbed Bronze



NI
Polished Nickel



SN
Satin Nickel





BELCASTEL 1 - CONTEMPORARY FINISHES

Item	Description	Overall Length or Diameter	Ctn Qty	Finishes	Price Code
MO6303	knob	1-3/8"	20	BNBDL, DBAC, NI, PC, SBZ, SN	[D]
MO6373	96 mm (3-3/4") CC	4-5/8"	15	BNBDL, DBAC, NI, PC, SBZ, SN	[E]
MO6373-128	128 mm (5-1/16") CC	5-7/8"	20	BNBDL, DBAC, NI, PC, SBZ, SN	[F]
MO6373-160	160 mm (6-5/16") CC	7-1/8"	10	BNBDL, DBAC, NI, PC, SBZ, SN	[G]
MO6373-12	12" CC appliance pull	13-1/4"	5	BNBDL, DBAC, NI, PC, SBZ, SN	[K]
MO6373-18	18" CC appliance pull	19-1/4"	5	BNBDL, DBAC, NI, PC, SBZ, SN	[K]

Switching from 3" CC to 96 mm?

Use Pull Escutcheons to cover the old holes. See PE07 on our website.

Finishes



BNBDL
Brushed
Pewter



DBAC
Brushed Oil
Rubbed Bronze



NI
Polished Nickel



PC
Polished
Chrome



SBZ
Satin Bronze



SN
Satin Nickel

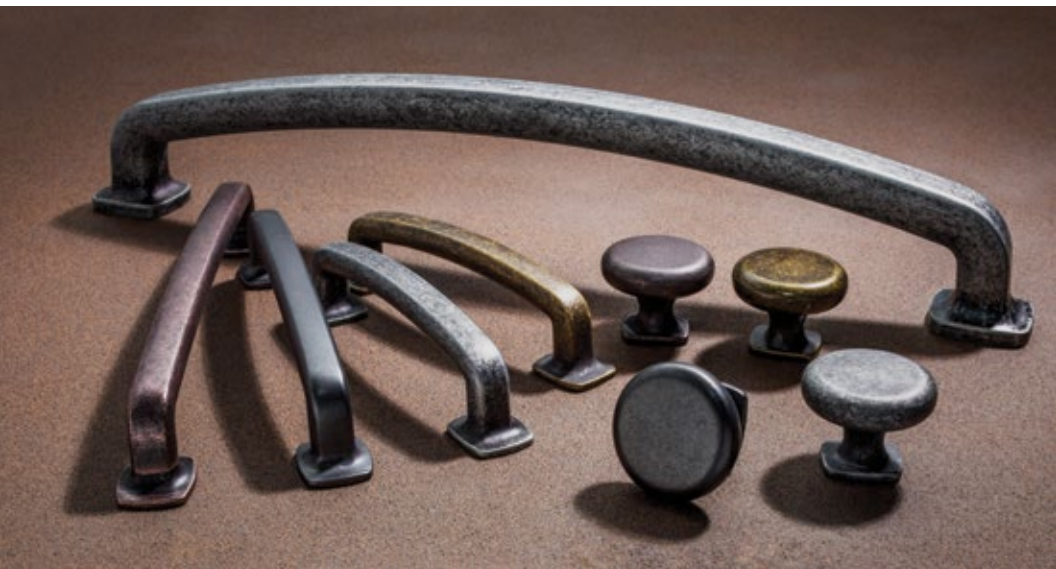

BELCASTEL 1 - TRADITIONAL FINISHES

Item	Description	Overall Length or Diameter	Ctn Qty	Finishes	Price Code
MO6303	knob	1-3/8"	20	ABM-D, DACM, DMAC, SIM-D	[D]
MO6373	96 mm (3-3/4") CC	4-5/8"	15	ABM-D, DACM, DMAC, SIM-D	[E]
MO6373-128	128 mm (5-1/16") CC	5-7/8"	20	ABM-D, DACM, DMAC, SIM-D	[F]
MO6373-160	160 mm (6-5/16") CC	7-1/8"	10	ABM-D, DACM, DMAC, SIM-D	[G]
MO6373-12	12" CC appliance pull	13-1/4"	5	ABM-D, DACM, DMAC, SIM-D	[K]
MO6373-18	18" CC appliance pull	19-1/4"	5	ABM-D, DACM, DMAC, SIM-D	[K]

Switching from 3" CC to 96 mm?

Use Pull Escutcheons to cover the old holes. See PE07 on our website.

Finishes



ABM-D

Distressed Antique
Brass



DACM

Gun Metal



DMAC

Distressed Oil
Rubbed Bronze



SIM-D

Distressed Antique
Silver

JEFFREY ALEXANDER®

by Hardware Resources





BOSWELL

Item	Description	Overall Length or Diameter	Ctn Qty	Finishes	Price Code
177-96	96 mm (3-3/4") CC	4-1/4"	15	BNBDL, DBAC, MB, PC, SN	[E]
177-128	128 mm (5-1/16") CC	5-9/16"	15	BNBDL, DBAC, MB, PC, SN	[F]
177-160	160 mm (6-5/16") CC	6-13/16"	10	BNBDL, DBAC, MB, PC, SN	[G]
177-192	192 mm (7-9/16") CC	8-1/16"	10	BNBDL, DBAC, MB, PC, SN	[G]
177-224	224 mm (8-7/8") CC	9-5/16"	10	BNBDL, DBAC, MB, PC, SN	[H]

Finishes



BNBDL
Brushed Pewter



DBAC
Brushed Oil
Rubbed Bronze



MB
Matte Black



PC
Polished Chrome



SN
Satin Nickel



BREMEN 1 - CONTEMPORARY FINISHES

Item	Description	Overall Length or Diameter	Ctn Qty	Finishes	Price Code
117	knob	1-1/4"	20	BNBDL, DBAC, NI, PC, SBZ, SN	[D]
527	96 mm (3-3/4") CC	4-5/8"	15	BNBDL, DBAC, NI, PC, SBZ, SN	[F]
527-128	128 mm (5-1/16") CC	5-7/8"	10	BNBDL, DBAC, NI, PC, SBZ, SN	[F]
527-160	160 mm (6-5/16") CC	7-1/8"	10	BNBDL, DBAC, NI, PC, SBZ, SN	[H]
527-12	12" CC appliance pull	13-1/16"	5	BNBDL, DBAC, NI, PC, SBZ, SN	[K]

Switching from 3" CC to 96 mm?

Use Pull Escutcheons to cover the old holes. See PE04 on our website.

Finishes



BNBDL
Brushed
Pewter



DBAC
Brushed Oil
Rubbed Bronze



NI
Polished Nickel



PC
Polished
Chrome



SBZ
Satin Bronze



SN
Satin Nickel



BREMEN 1 - TRADITIONAL FINISHES

Item	Description	Overall Length or Diameter	Ctn Qty	Finishes	Price Code
117	knob	1-1/4"	20	ABM-D, ABSB, DACM, DMAC, SIM	[D]
527	96 mm (3-3/4") CC	4-5/8"	15	ABM-D, ABSB, DACM, DMAC, SIM	[F]
527-128	128 mm (5-1/16") CC	5-7/8"	10	ABM-D, ABSB, DACM, DMAC, SIM	[F]
527-160	160 mm (6-5/16") CC	7-1/8"	10	ABM-D, ABSB, DACM, DMAC, SIM	[H]
527-12	12" CC appliance pull	13-1/16"	5	ABM-D, ABSB, DACM, DMAC, SIM	[K]

Switching from 3" CC to 96 mm?

Use Pull Escutcheons to cover the old holes. See PE04 on our website.

Finishes



ABM-D
Distressed Antique
Brass



ABSB
Antique Brushed
Satin Brass



DACM
Gun Metal



DMAC
Distressed Oil
Rubbed Bronze



SIM
Distressed Antique
Silver

JEFFREY ALEXANDER®

by Hardware Resources



BREMEN 2

Item	Description	Overall Length or Diameter	Ctn Qty	Finishes	Price Code
127	knob (barrel)	1-3/16"	20	ABSB, DACM, DBAC, DMAC, NI, SN	[D]
137	knob (stacked)	1-1/4"	30	ABSB, DACM, DBAC, DMAC, NI, SN	[D]
537	96 mm (3-3/4") CC	4-3/16"	20	ABSB, DACM, DBAC, DMAC, NI, SN	[E]
537-128	128 mm (5-1/16") CC	5-7/16"	10	ABSB, DACM, DBAC, DMAC, NI, SN	[F]
537-160	160 mm (6-5/16") CC	6-9/16"	10	ABSB, DACM, DBAC, DMAC, NI, SN	[F]
537-12	12" CC appliance pull	12-11/16"	5	ABSB, DACM, DBAC, DMAC, NI, SN	[K]

Switching from 3" CC to 96 mm?

Use Pull Escutcheons to cover the old holes. See PE02 on our website.

Finishes



ABSB
Antique
Brushed Satin
Brass



DACM
Gun Metal



DBAC
Brushed Oil
Rubbed Bronze



DMAC
Distressed Oil
Rubbed Bronze



NI
Polished Nickel



SN
Satin Nickel

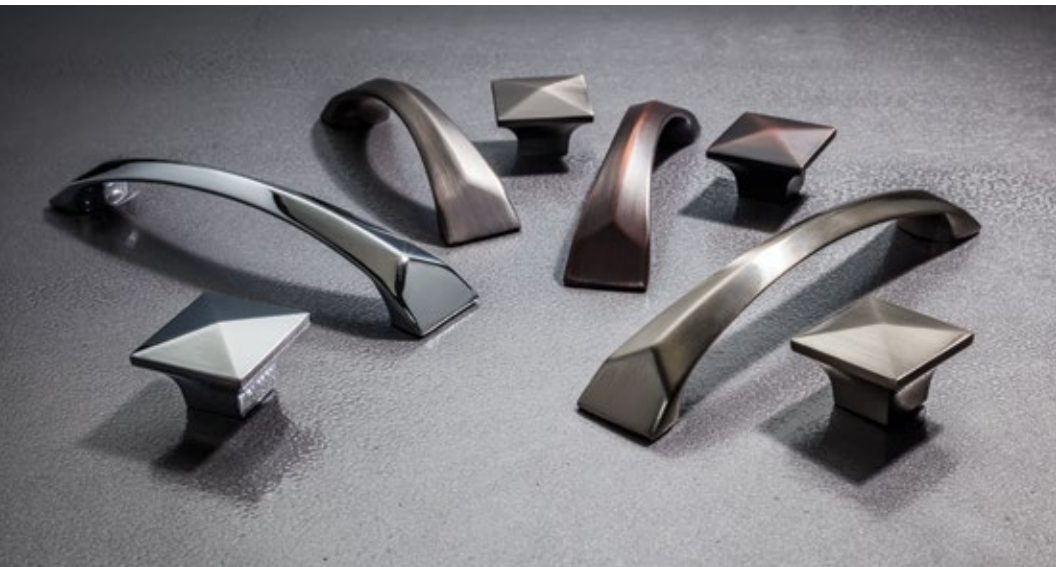

CAIRO

Item	Description	Overall Length or Diameter	Ctn Qty	Finishes	Price Code
595	knob	1-1/4"	20	BNBDL, DBAC, PC, SN	[D]
595-96	96 mm (3-3/4") CC	4-13/16"	20	BNBDL, DBAC, PC, SN	[E]
595-128	128 mm (5-1/16") CC	6-1/16"	15	BNBDL, DBAC, PC, SN	[E]

Finishes

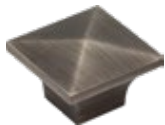

BNBDL
Brushed Pewter

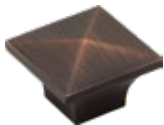

DBAC
Brushed Oil
Rubbed Bronze



PC
Polished Chrome



SN
Satin Nickel



JEFFREY ALEXANDER®

by Hardware Resources



CALLIE

US Patent # 790,315

Item	Description	Overall Length or Diameter	Ctn Qty	Finishes	Price Code
839-3	3" CC	4-3/16"	20	BNBDL, DBAC, NI, PC, SN	[E]
839-96	96 mm (3-3/4") CC	4-15/16"	15	BNBDL, DBAC, NI, PC, SN	[F]
839-128	128 mm (5-1/16") CC	6-1/4"	15	BNBDL, DBAC, NI, PC, SN	[G]
839-160	160 mm (6-5/16") CC	7-1/2"	10	BNBDL, DBAC, NI, PC, SN	[H]

Finishes



BNBDL
Brushed Pewter



DBAC
Brushed Oil Rubbed Bronze



NI
Polished Nickel



PC
Polished Chrome



SN
Satin Nickel





CORDOVA

Item	Description	Overall Length or Diameter	Ctn Qty	Finishes	Price Code
0251	knob (left)	1-3/8"	25	ABSB, BNBDL, DBAC, SN	[C]
Z110	knob (right)	1-3/16"	30	ABSB, BNBDL, DBAC, SN	[B]
Z111	knob (center)	1-1/4"	30	ABSB, BNBDL, DBAC, SN	[C]
Z281	3" CC	3-3/8"	20	ABSB, BNBDL, DBAC, SN	[D]
Z280	96 mm (3-3/4") CC	4-3/16"	20	ABSB, BNBDL, DBAC, SN	[E]
Z281-128	128 mm (5-1/16") CC	5-7/16"	10	ABSB, BNBDL, DBAC, SN	[F]
Z281-160	160 mm (6-5/16") CC	6-11/16"	10	ABSB, BNBDL, DBAC, SN	[H]
Z281-12	12" CC appliance pull	12-3/4"	5	ABSB, BNBDL, DBAC, SN	[K]
Z281-18	18" CC appliance pull	18-3/4"	5	ABSB, BNBDL, DBAC, SN	[K]

Finishes



ABSB
Antique Brushed
Satin Brass



BNBDL
Brushed Pewter
(0251 only)



BNBDL
Distressed Pewter



DBAC
Brushed Oil
Rubbed Bronze



SN
Satin Nickel

JEFFREY ALEXANDER®

by Hardware Resources



DELGADO

US Patent # D612,703; D598,269

Item	Description	Overall Length or Diameter	Ctn Qty	Finishes	Price Code
519	knob	1-9/16"	30	ABSB, BNBDL, DBAC, NI, SN	[F]
519-96	96 mm (3-3/4") CC	4-1/4"	10	ABSB, BNBDL, DBAC, NI, SN	[H]
519-128	128 mm (5-1/16") CC	5-9/16"	10	ABSB, BNBDL, DBAC, NI, SN	[K]
519-160	160 mm (6-5/16") CC	6-13/16"	10	ABSB, BNBDL, DBAC, NI, SN	[K]
519-12	12" CC appliance pull	12-1/2"	5	ABSB, BNBDL, DBAC, NI, SN	[K]
519-18	18" CC appliance pull	18-1/2"	5	ABSB, BNBDL, DBAC, NI, SN	[K]

Finishes



ABSB
Antique Brushed
Satin Brass



BNBDL
Brushed Pewter



DBAC
Brushed Oil
Rubbed Bronze



NI
Polished Nickel



SN
Satin Nickel

JEFFREY ALEXANDER®

by Hardware Resources



DELMAR

US Patent # D680,409; D680,414; D680,408

Item	Description	Overall Length or Diameter	Ctn Qty	Finishes	Price Code
585	small knob	1"	20	BNBDL, DACM, DBAC, DP, SN	[F]
585L	large knob	1-1/4"	20	BNBDL, DACM, DBAC, DP, SN	[G]
585-96	96 mm (3-3/4") CC	4-1/2"	10	BNBDL, DACM, DBAC, DP, SN	[H]
585-128	128 mm (5-1/16") CC	5-13/16"	10	BNBDL, DACM, DBAC, DP, SN	[J]
585-160	160 mm (6-5/16") CC	7-1/16"	10	BNBDL, DACM, DBAC, DP, SN	[K]
585-12	12" CC appliance pull	13-1/4"	5	BNBDL, DACM, DBAC, DP, SN	[K]

Finishes



BNBDL
Brushed Pewter



DACM
Gun Metal



DBAC
Brushed Oil
Rubbed Bronze



DP
Distressed Pewter



SN
Satin Nickel

JEFFREY ALEXANDER®

by Hardware Resources



DURHAM

Item	Description	Overall Length or Diameter	Ctn Qty	Finishes	Price Code
3980	knob	1-1/4"	20	ABSB, BNBDL, DACM, DBAC, ORB, PC, SN	[D]
Z290-3	3" CC	3-3/8"	25	ABSB, BNBDL, DACM, DBAC, ORB, PC, SN	[D]
Z290-96	96 mm (3-3/4") CC	4-1/4"	20	ABSB, BNBDL, DACM, DBAC, ORB, PC, SN	[D]
Z290-128	128 mm (5-1/16") CC	5-1/2"	15	ABSB, BNBDL, DACM, DBAC, ORB, PC, SN	[G]
Z290-160	160 mm (6-5/16") CC	6-3/4"	10	ABSB, BNBDL, DACM, DBAC, ORB, PC, SN	[H]
Z290-12	12" CC appliance pull	13"	5	ABSB, BNBDL, DACM, DBAC, ORB, PC, SN	[K]

Switching from 3" CC to 96 mm?

Use Pull Escutcheons to cover the old holes. See PE02 on our website.

Finishes



ABSB
Antique
Brushed Satin
Bronze



BNBDL
Brushed
Pewter



DACM
Gun Metal



DBAC
Brushed
Rubbed Bronze



ORB
Dark Bronze



PC
Polished
Chrome



SN
Satin Nickel

JEFFREY ALEXANDER®

by Hardware Resources



DOMINIQUE **NEW!**

Item	Description	Overall Length or Diameter	Ctn Qty	Finishes	Price Code
845 NEW	square knob	1-1/8"	20	BG, BNBDL, DBAC, MB, PC, SBZ, SN	[D]
845T NEW	T knob	2"	20	BG, BNBDL, DBAC, MB, PC, SBZ, SN	[D]
845TL NEW	long T knob	2-1/4"	20	BG, BNBDL, DBAC, MB, PC, SBZ, SN	[E]
845-96 NEW	96 mm (3-3/4") CC	5-3/4"	10	BG, BNBDL, DBAC, MB, PC, SBZ, SN	[F]
845-128 NEW	128 mm (5-1/16") CC	7-1/16"	10	BG, BNBDL, DBAC, MB, PC, SBZ, SN	[F]
845-160 NEW	160 mm (6-5/16") CC	8-5/16"	10	BG, BNBDL, DBAC, MB, PC, SBZ, SN	[G]
845-192 NEW	192 mm (7-9/16") CC	9-9/16"	10	BG, BNBDL, DBAC, MB, PC, SBZ, SN	[H]
845-305 NEW	305 mm (12") CC	14"	10	BG, BNBDL, DBAC, MB, PC, SBZ, SN	[K]
845-12 NEW	12" CC appliance pull	15"	5	BG, BNBDL, DBAC, MB, PC, SBZ, SN	[K]
845-18 NEW	18" CC appliance pull	21"	5	BG, BNBDL, DBAC, MB, PC, SBZ, SN	[K]

Finishes



BG
Brushed Gold



BNBDL
Brushed Pewter



DBAC
Brushed Oil Rubbed Bronze



MB
Matte Black



PC
Polished Chrome



SBZ
Satin Bronze



SN
Satin Nickel







ELARA

Item	Description	Overall Length or Diameter	Ctn Qty	Finishes	Price Code
484	knob	1-1/4"	20	BNBDL, DBAC, MB, PC, SBZ, SN	[D]
484-32	32 mm (1-1/4") CC	2-1/16"	10	BNBDL, DBAC, MB, PC, SBZ, SN	[D]
484-396	3" CC, 96 mm (3-3/4") CC	4-9/16"	10	BNBDL, DBAC, MB, PC, SBZ, SN	[F]
484-128160	128 mm (5") CC, 160 mm (6-1/4") CC	7-1/8"	10	BNBDL, DBAC, MB, PC, SBZ, SN	[H]
484-192224	192 mm (7-9/16") CC, 224 mm (8 13/16") CC	9-5/8"	5	BNBDL, DBAC, MB, PC, SBZ, SN	[J]
484-305	305 mm (12") CC	12-13/16"	5	BNBDL, DBAC, MB, PC, SBZ, SN	[K]

Finishes



BNBDL

Brushed Pewter



DBAC

Brushed Oil
Rubbed Bronze



MB

Matte Black



PC

Polished
Chrome



SBZ

Satin Bronze



SN

Satin Nickel

JEFFREY ALEXANDER®

by Hardware Resources



ELLA

US Patent # D737,112; D728,343

Item	Description	Overall Length or Diameter	Ctn Qty	Finishes	Price Code
165	knob	1-1/4"	20	BNBDL, DBAC, NI, PC, SN	[E]
165-96	96 mm (3-3/4") CC	4-1/2"	10	BNBDL, DBAC, NI, PC, SN	[G]
165-128	128 mm (5-1/16") CC	5-13/16"	10	BNBDL, DBAC, NI, PC, SN	[H]
165-160	160 mm (6-5/16") CC	7-1/16"	10	BNBDL, DBAC, NI, PC, SN	[J]
165-12	12" CC appliance pull	13"	5	BNBDL, DBAC, NI, PC, SN	[K]

Finishes



BNBDL
Brushed Pewter



DBAC
Brushed Oil
Rubbed Bronze



NI
Polished Nickel



PC
Polished Chrome



SN
Satin Nickel



HARLOW

Item	Description	Overall Length or Diameter	Ctn Qty	Base Finishes	Price Code
G110	small egg	1-1/4"	10	BNBDL, DBAC, PC, SN	[G]
G110L	large egg	1-5/8"	10	BNBDL, DBAC, PC, SN	[J]
G120	small button	1-7/16"	10	BNBDL, DBAC, PC, SN	[G]
G120L	large button	1-3/4"	10	BNBDL, DBAC, PC, SN	[J]
G130	small sphere	1-1/16"	10	BNBDL, DBAC, PC, SN	[G]
G130L	large sphere	1-3/8"	10	BNBDL, DBAC, PC, SN	[H]
G140	small square	1"	10	BNBDL, DBAC, PC, SN	[G]
G140L	large square	1-3/8"	10	BNBDL, DBAC, PC, SN	[J]
G150	small faceted	1"	10	BNBDL, DBAC, PC, SN	[G]
G150L	large faceted	1-1/4"	10	BNBDL, DBAC, PC, SN	[H]

Base Finishes



BNBDL
Brushed Pewter



DBAC
Brushed Oil
Rubbed Bronze



PC
Polished Chrome



SN
Satin Nickel

JEFFREY ALEXANDER®

by Hardware Resources



HAYWORTH

US Patent # D787,297; D787,296

Item	Description	Overall Length or Diameter	Ctn Qty	Finishes	Price Code
885	knob	1-1/8"	25	NI, PC, SN	[E]
885L	T knob	2"	25	NI, PC, SN	[E]
885-96	96 mm (3-3/4") CC	4-3/4"	10	NI, PC, SN	[G]
885-128	128 mm (5-1/16") CC	6"	10	NI, PC, SN	[H]
885-160	160 mm (6-5/16") CC	7-1/4"	10	NI, PC, SN	[H]
885-192	192 mm (7-9/16") CC	8-1/2"	10	NI, PC, SN	[J]
885-224	224 mm (8-13/16") CC	9-3/4"	10	NI, PC, SN	[J]
885-305	12" CC appliance pull	12-15/16"	10	NI, PC, SN	[K]

Finishes



NI

Polished Nickel



PC

Polished Chrome



SN

Satin Nickel

JEFFREY ALEXANDER®

by Hardware Resources



JEFFREY ALEXANDER®

by Hardware Resources

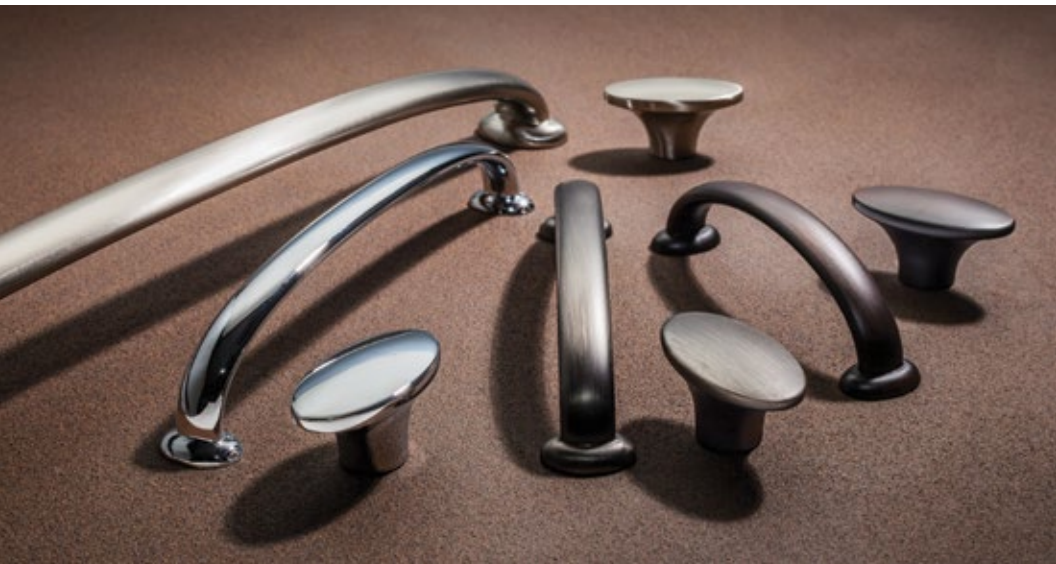

HUDSON

Item	Description	Overall Length or Diameter	Ctn Qty	Finishes	Price Code
650	knob	1-7/8"	25	BNBDL, DBAC, PC, SN	[D]
650-96	96 mm (3-3/4") CC	4-3/8"	30	BNBDL, DBAC, PC, SN	[E]
650-128	128 mm (5-1/16") CC	5-5/8"	25	BNBDL, DBAC, PC, SN	[F]
650-160	160 mm (6-5/16") CC	6-15/16"	10	BNBDL, DBAC, PC, SN	[G]
650-12	12" CC appliance pull	13"	5	BNBDL, DBAC, PC, SN	[K]

Switching from 3" CC to 96 mm?

Use Pull Escutcheons to cover the old holes. See PE06 on our website.

Finishes



BNBDL
Brushed Pewter



DBAC
Brushed Oil
Rubbed Bronze



PC
Polished Chrome



SN
Satin Nickel

JEFFREY ALEXANDER®

by Hardware Resources



KATHARINE

US Patent # D728,341; D729,037

Item	Description	Overall Length or Diameter	Ctn Qty	Finishes	Price Code
188	small knob	7/8"	20	BNBDL, DBAC, PC, SN	[E]
188L	large knob	1"	15	BNBDL, DBAC, PC, SN	[F]
188-96	96 mm (3-3/4") CC	4-3/8"	15	BNBDL, DBAC, PC, SN	[G]
188-128	128 mm (5-1/16") CC	5-11/16"	15	BNBDL, DBAC, PC, SN	[H]
188-160	160 mm (6-5/16") CC	6-15/16"	10	BNBDL, DBAC, PC, SN	[J]

Switching from 3" CC to 96 mm?

Use Pull Escutcheons to cover the old holes. See PE03 on our website.

Finishes



BNBDL
Brushed Pewter



DBAC
Brushed Oil
Rubbed Bronze



PC
Polished Chrome



SN
Satin Nickel





KEY GRANDE

Item	Description	Overall Length or Diameter	Ctn Qty	Finishes	Price Code
596	96 mm (3-3/4") CC	5-3/8"	20	BG, SN	[H]
5128	128 mm (5-1/16") CC	6-5/8"	20	BG, SN	[H]
5192	192 mm (7-9/16") CC	9-1/8"	10	BG, SN	[J]
5224	224 mm (8-13/16") CC	10-3/8"	10	BG, SN	[J]
5319	319 mm (12-9/16") CC	14-1/8"	10	BG, SN	[K]
5480	480 mm (18-7/8") CC	20-1/2"	10	SN	[K]
5673	673 mm (26-1/2") CC	28-1/16"	10	SN	[K]
5900	900 mm (35-7/16") CC	37"	5	SN	[K]

Switching from 3" CC to 96 mm?

Use Pull Escutcheons to cover the old holes. See PE03 on our website.

Finishes



BG

Brushed Gold



SN

Satin Nickel

JEFFREY ALEXANDER®

by Hardware Resources



KEY WEST & KEY LARGO



Item	Description	Overall Length or Diameter	Ctn Qty	Finishes	Price Code
48	T knob	1-7/8"	30	BG, MB, ORB, SBZ, SN	[D]
146	96 mm (3-3/4") CC	5-3/4"	10	BG, MB, ORB, SBZ, SN	[F]
152	96 mm (3-3/4") CC	6"	10	BG, MB, ORB, SBZ, SN	[F]
178	128 mm (5-1/16") CC	7"	10	BG, MB, ORB, SBZ, SN	[G]
242	192 mm (7-9/16") CC	9-1/2"	10	BG, MB, SBZ, SN	[G]
274	224 mm (8-13/16") CC	10-3/4"	10	BG, MB, SBZ, SN	[H]
370	319 mm (12-9/16") CC	14-9/16"	10	BG, MB, SBZ, SN	[H]
530	480 mm (18-7/8") CC	20-7/8"	10	SN	[J]
722	673 mm (26-1/2") CC	28-7/16"	10	SN	[K]
950	900 mm (35-7/16") CC	37-3/8"	10	SN	[K]

Switching from 3" CC to 96 mm?

Use Pull Escutcheons to cover the old holes. See PE02 on our website.

Finishes



BG

Brushed Gold



MB

Matte Black



ORB

Dark Bronze



SBZ

Satin Bronze



SN

Satin Nickel

JEFFREY ALEXANDER®

by Hardware Resources



JEFFREY ALEXANDER®

by Hardware Resources



LAFAYETTE

US Patent # D605,924; D602,334; D637,059

Item	Description	Overall Length or Diameter	Ctn Qty	Finishes	Price Code
218	fleur-de-lis knob	1-3/8"	30	ABSB, BNBDL, DBAC, SN	[F]
317	circles knob	1-3/8"	20	ABSB, BNBDL, DBAC, SN	[F]
417	Baroque (pattern) knob	1-3/8"	30	ABSB, BNBDL, DBAC, SN	[F]
317-96	96 mm (3-3/4") CC	4-3/8"	20	ABSB, BNBDL, DBAC, SN	[G]
317-128	128 mm (5-1/16") CC	5-5/8"	20	ABSB, BNBDL, DBAC, SN	[H]
317-160	160 mm (6-5/16") CC	6-7/8"	15	ABSB, BNBDL, DBAC, SN	[H]
317-12	12" CC appliance pull	12-15/16"	5	ABSB, BNBDL, DBAC, SN	[K]

Switching from 3" CC to 96 mm?

Use Pull Escutcheons to cover the old holes. See PE02 on our website.

Finishes



ABSB
Antique Brushed
Satin Bronze



BNBDL
Brushed Pewter



DBAC
Brushed Oil
Rubbed Bronze



SN
Satin Nickel

JEFFREY ALEXANDER®

by Hardware Resources



LEXA

US Patent # D718,111; D719,008

Item	Description	Overall Length or Diameter	Ctn Qty	Finishes	Price Code
259	knob	2"	30	BN, BNBDL, DBAC, PC, SN	[E]
259-96	96 mm (3-3/4") CC	4-3/16"	15	BN, BNBDL, DBAC, PC, SN	[H]
259-128	128 mm (5-1/16") CC	5-7/16"	10	BN, BNBDL, DBAC, PC, SN	[H]
259-160	160 mm (6-5/16") CC	6-11/16"	10	BN, BNBDL, DBAC, PC, SN	[J]
259-192	192 mm (7-9/16") CC	8"	10	BN, BNBDL, DBAC, PC, SN	[J]

Finishes



BN

Black Nickel



BNBDL

Brushed Pewter



DBAC

Brushed Oil
Rubbed Bronze



PC

Polished Chrome



SN

Satin Nickel

JEFFREY ALEXANDER®

by Hardware Resources



LEYTON

Item	Description	Overall Length or Diameter	Ctn Qty	Finishes	Price Code
286-96	96 mm (3-3/4") CC	5-1/8"	10	BNBDL, DBAC, NI, PC, SBZ, SN	[F]
286-128	128 mm (5-1/16") CC	6-3/8"	10	BNBDL, DBAC, NI, PC, SBZ, SN	[G]
286-160	160 mm (6-5/16") CC	7-11/16"	10	BNBDL, DBAC, NI, PC, SBZ, SN	[H]
286-192	192 mm (7-9/16") CC	8-15/16"	10	BNBDL, DBAC, NI, PC, SBZ, SN	[H]
286-224	224 mm (8-13/16") CC	10-3/16"	10	BNBDL, DBAC, NI, PC, SBZ, SN	[J]

Finishes



BNBDL
Brushed
Pewter



DBAC
Brushed Oil
Rubbed Bronze



NI
Polished Nickel



PC
Polished
Chrome



SBZ
Satin Bronze



SN
Satin Nickel

JEFFREY ALEXANDER®

by Hardware Resources



JEFFREY ALEXANDER®

by Hardware Resources



LYON

Item	Description	Overall Length or Diameter	Ctn Qty	Finishes	Price Code
3991	egg knob	1-9/16"	25	AB, BG, BLK, BNBDL, DACM, DBAC, NI, ORB, PC, SIM, SBZ, SN	[E]
8233	3" CC	4-15/16"	25	AB, BG, BLK, BNBDL, DACM, DBAC, NI, ORB, PC, SIM, SBZ, SN	[D]

Finishes



AB
Brushed
Antique Brass



BG
Brushed Gold



BLK
Matte Black



BNBDL
Brushed
Pewter



DACM
Gun Metal



DBAC
Brushed Oil
Rubbed Bronze



NI
Polished Nickel



ORB
Dark Bronze



PC
Polished
Chrome



SIM
Distressed
Antique Silver



SBZ
Satin Bronze



SN
Satin Nickel

JEFFREY ALEXANDER®

by Hardware Resources

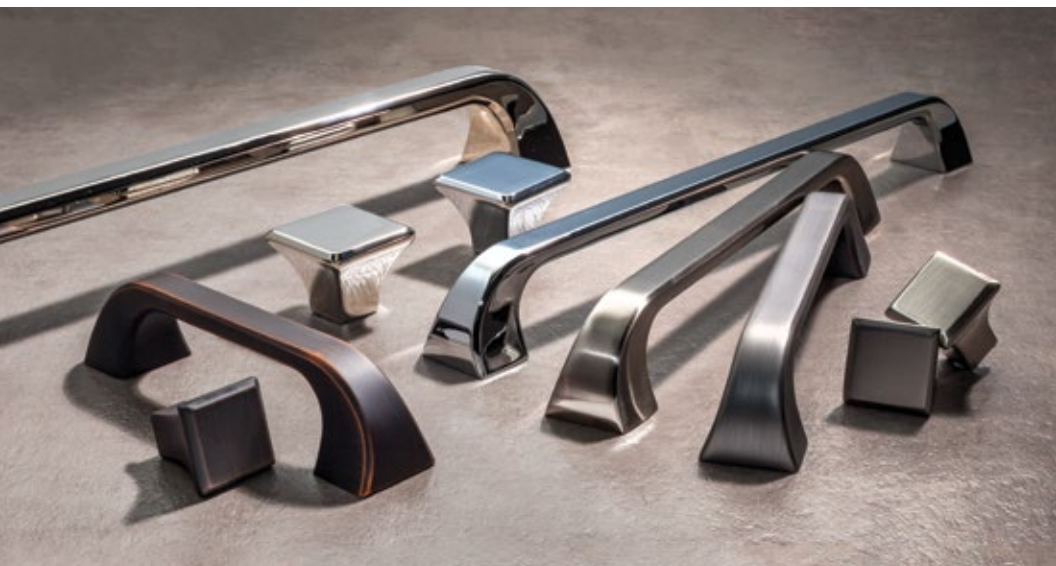

MARLO

US Patent # D786,648; D790,316

Item	Description	Overall Length or Diameter	Ctn Qty	Finishes	Price Code
972S	small knob	7/8"	30	BNBDL, DBAC, NI, PC, SN	[D]
972	medium knob	1-1/8"	20	BNBDL, DBAC, NI, PC, SN	[E]
972L	large knob	1-1/4"	20	BNBDL, DBAC, NI, PC, SN	[F]
972-96	96 mm (3-3/4") CC	4-1/2"	10	BNBDL, DBAC, NI, PC, SN	[G]
972-128	128 mm (5-1/16") CC	5-13/16"	10	BNBDL, DBAC, NI, PC, SN	[H]
972-160	160 mm (6-5/16") CC	7-1/16"	10	BNBDL, DBAC, NI, PC, SN	[J]
972-224	224 mm (8-13/16") CC	9-3/4"	15	BNBDL, DBAC, NI, PC, SN	[J]
972-305	305 mm (12") CC	12-3/4"	10	BNBDL, DBAC, NI, PC, SN	[K]
972-12	12" CC appliance pull	13"	5	BNBDL, DBAC, NI, PC, SN	[K]

Finishes



BNBDL
Brushed Pewter



DBAC
Brushed Oil
Rubbed Bronze



NI
Polished Nickel



PC
Polished Chrome



SN
Satin Nickel

JEFFREY ALEXANDER®

by Hardware Resources



JEFFREY ALEXANDER®

by Hardware Resources



MERRICK

Item	Description	Overall Length or Diameter	Ctn Qty	Finishes	Price Code
549-96	96 mm (3-3/4") CC	4-3/16"	25	BNBDL, DBAC, MB, PC, SBZ, SN	[E]
549-128	128 mm (5-1/16") CC	5-1/2"	15	BNBDL, DBAC, MB, PC, SBZ, SN	[E]
549-160	160 mm (6-5/16") CC	6-3/4"	15	BNBDL, DBAC, MB, PC, SBZ, SN	[F]
549-192	192 mm (7-9/16") CC	8"	20	BNBDL, DBAC, MB, PC, SBZ, SN	[F]
549-320	320 mm (12-5/8") CC	13-1/16"	10	BNBDL, DBAC, MB, PC, SBZ, SN	[K]

Finishes



BNBDL
Brushed
Pewter



DBAC
Brushed Oil
Rubbed Bronze



MB
Matte Black



PC
Polished
Chrome



SBZ
Satin Bronze



SN
Satin Nickel

JEFFREY ALEXANDER®

by Hardware Resources



MILAN 1

Item	Description	Overall Length or Diameter	Ctn Qty	Finishes	Price Code
1091	knob	1-3/16"	20	AB, AEM, BNBDL, DACM, DBAC, PC, SN	[E]
1092	96 mm (3-3/4") CC	4-1/4"	20	AB, AEM, BNBDL, DACM, DBAC, PC, SN	[F]
1092-128	128 mm (5-1/16") CC	5-9/16"	25	AB, AEM, BNBDL, DACM, DBAC, PC, SN	[G]
1092-160	160 mm (6-5/16") CC	6-13/16"	20	AB, AEM, BNBDL, DACM, DBAC, PC, SN	[H]
1092-12	12" CC appliance pull	12-13/16"	5	AB, AEM, BNBDL, DACM, DBAC, PC, SN	[K]

Switching from 3" CC to 96 mm?

Use Pull Escutcheons to cover the old holes. See PE03 on our website.

Finishes



AB
Brushed
Antique
Brass



AEM
Lightly
Distressed
Antique Brass



BNBDL
Brushed
Pewter



DACM
Gun Metal



DBAC
Brushed Oil
Rubbed
Bronze



PC
Polished
Chrome



SN
Satin Nickel

JEFFREY ALEXANDER®

by Hardware Resources



MIRADA

Item	Description	Overall Length or Diameter	Ctn Qty	Finishes	Price Code
81021	16 mm (5/8") CC knob	1-9/16"	30	ABSB, BNBDL, DBAC, MB, PC, SN	[D]
80152-96	96 mm (3-3/4") CC	5-9/16"	20	ABSB, BNBDL, DBAC, MB, PC, SN	[G]
80152-128	128 mm (5-1/16") CC	6-13/16"	20	ABSB, BNBDL, DBAC, MB, PC, SN	[H]
80152-160	160 mm (6-5/16") CC	8-1/16"	15	ABSB, BNBDL, DBAC, MB, PC, SN	[H]

Finishes

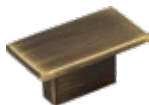

ABSB
Antique
Brushed Satin
Brass

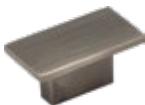

BNBDL
Brushed
Pewter



DBAC
Brushed Oil
Rubbed Bronze



MB
Matte Black



PC
Polished
Chrome



SN
Satin Nickel

JEFFREY ALEXANDER®

by Hardware Resources



JEFFREY ALEXANDER®

by Hardware Resources



PHILIP *NEW!*

Item	Description	Overall Length or Diameter	Ctn Qty	Finishes	Price Code
767 <i>NEW</i>	knob	1-1/4"	25	BG, BNBDL, DBAC, MB, PC, SBZ, SN	[D]
767-96 <i>NEW</i>	96 mm (3-3/4") CC	5"	15	BG, BNBDL, DBAC, MB, PC, SBZ, SN	[E]
767-128 <i>NEW</i>	128 mm (5-1/16") CC	6-5/16"	10	BG, BNBDL, DBAC, MB, PC, SBZ, SN	[F]
767-160 <i>NEW</i>	160 mm (6-5/16") CC	7-9/16"	10	BG, BNBDL, DBAC, MB, PC, SBZ, SN	[G]

Finishes



BG
Brushed
Gold



BNBDL
Brushed
Pewter



DBAC
Brushed Oil
Rubbed Bronze



MB
Matte Black



PC
Polished
Chrome



SBZ
Satin Bronze



SN
Satin Nickel

JEFFREY ALEXANDER®

by Hardware Resources



RAE

Item	Description	Overall Length or Diameter	Ctn Qty	Finishes	Price Code
667S	small knob	1-1/16"	20	BNBDL, DBAC, NI, PC, SN	[D]
667	medium knob	1-1/4"	20	BNBDL, DBAC, NI, PC, SN	[E]
667L	large knob	1-3/8"	20	BNBDL, DBAC, NI, PC, SN	[F]
667-3	3" CC	3-7/16"	20	BNBDL, DBAC, NI, PC, SN	[F]
667-96	96 mm (3-3/4") CC	4-3/16"	20	BNBDL, DBAC, NI, PC, SN	[G]
667-128	128 mm (5-1/16") CC	5-1/2"	15	BNBDL, DBAC, NI, PC, SN	[H]
667-160	160 mm (6-5/16") CC	6-3/4"	10	BNBDL, DBAC, NI, PC, SN	[J]
667-224	224 mm (8-13/16") CC	9-1/4"	10	BNBDL, DBAC, NI, PC, SN	[J]
667-305	305 mm (12") CC	12-9/16"	10	BNBDL, DBAC, NI, PC, SN	[K]
667-12	12" CC appliance pull	12-13/16"	5	BNBDL, DBAC, NI, PC, SN	[K]
667-18	18" CC appliance pull	18-13/16"	5	BNBDL, DBAC, NI, PC, SN	[K]

Finishes



BNBDL
Brushed Pewter



DBAC
Brushed Oil
Rubbed Bronze



NI
Polished Nickel



PC
Polished Chrome



SN
Satin Nickel



REGAN

Item	Description	Overall Length or Diameter	Ctn Qty	Finishes	Price Code
847-96	96 mm (3-3/4") CC	5-9/16"	25	BNBDL, DBAC, PC, SN	[D]
847-128	128 mm (5-1/16") CC	6-13/16"	25	BNBDL, DBAC, PC, SN	[D]
847-160	160 mm (6-5/16") CC	8-1/16"	25	BNBDL, DBAC, PC, SN	[D]

Finishes



BNBDL
Brushed Pewter



DBAC
Brushed Oil
Rubbed Bronze



PC
Polished Chrome



SN
Satin Nickel

JEFFREY ALEXANDER®

by Hardware Resources



JEFFREY ALEXANDER®

by Hardware Resources



ROMAN *NEW!*

Item	Description	Overall Length or Diameter	Ctn Qty	Finishes	Price Code
944 <i>NEW</i>	knob	1-1/4"	20	BG, BNBDL, DBAC, MB, NI, PC, SBZ, SN	[D]
944-96 <i>NEW</i>	96 mm (3-3/4") CC	4-15/16"	10	BG, BNBDL, DBAC, MB, NI, PC, SBZ, SN	[E]
944-128 <i>NEW</i>	128 mm (5-1/16") CC	6-1/4"	10	BG, BNBDL, DBAC, MB, NI, PC, SBZ, SN	[F]
944-160 <i>NEW</i>	160 mm (6-5/16") CC	7-1/2"	10	BG, BNBDL, DBAC, MB, NI, PC, SBZ, SN	[F]
944-192 <i>NEW</i>	192 mm (7-9/16") CC	8-3/4"	10	BG, BNBDL, DBAC, MB, NI, PC, SBZ, SN	[G]
944-224 <i>NEW</i>	224 mm (8-13/16") CC	10"	15	BG, BNBDL, DBAC, MB, NI, PC, SBZ, SN	[H]
944-305 <i>NEW</i>	305 mm (12") CC	13-3/16"	10	BG, BNBDL, DBAC, MB, NI, PC, SBZ, SN	[K]
944-12 <i>NEW</i>	12" CC appliance pull	13-5/8"	5	BG, BNBDL, DBAC, MB, NI, PC, SBZ, SN	[K]

Finishes



BG
Brushed
Gold



BNBDL
Brushed
Pewter



DBAC
Brushed Oil
Rubbed
Bronze



MB
Matte Black



NI
Polished
Nickel



PC
Polished
Chrome



SBZ
Satin Bronze



SN
Satin Nickel



ROYCE

Item	Description	Overall Length or Diameter	Ctn Qty	Finishes	Price Code
431	knob (rounded)	1-3/16"	30	BNBDL, DBAC, PC, SN	[D]
595	knob (pyramid)	1-1/4"	20	BNBDL, DBAC, PC, SN	[D]
798-96	96 mm (3-3/4") CC	5-1/2"	10	BNBDL, DBAC, PC, SN	[E]
798-128	128 mm (5-1/16") CC	6-3/4"	10	BNBDL, DBAC, PC, SN	[F]
798-160	160 mm (6-5/16") CC	8-1/16"	10	BNBDL, DBAC, PC, SN	[G]

Finishes



BNBDL
Brushed Pewter



DBAC
Brushed Oil
Rubbed Bronze



PC
Polished Chrome



SN
Satin Nickel



SONOMA

Item	Description	Overall Length or Diameter	Ctn Qty	Finishes	Price Code
431	knob	1-3/16"	30	BNBDL, DBAC, MB, PC, SN	[D]
4128	128 mm (5-1/16") CC	6-5/16"	20	BNBDL, DBAC, MB, PC, SN	[F]
4160	160 mm (6-5/16") CC	8"	20	BNBDL, DBAC, MB, PC, SN	[G]
4192	192 mm (7-9/16") CC	9-5/8"	10	BNBDL, DBAC, MB, PC, SN	[H]
4288	288 mm (11-3/8") CC	14-7/16"	10	BNBDL, DBAC, MB, PC, SN	[K]

Finishes



BNBDL
Brushed Pewter



DBAC
Brushed Oil
Rubbed Bronze



MB
Matte Black



PC
Polished Chrome



SN
Satin Nickel



SULLIVAN

Item	Description	Overall Length or Diameter	Ctn Qty	Finishes	Price Code
752-19	19 mm (3/4") CC	1-1/4"	25	BNBDL, DBAC, MB, PC, SN	[D]
752-96	96 mm (3-3/4") CC	4-1/2"	20	BNBDL, DBAC, MB, PC, SN	[D]
752-128	128 mm (5-1/16") CC	5-13/16"	10	BNBDL, DBAC, MB, PC, SN	[F]
752-160	160 mm (6-1/4") CC	7-1/16"	10	BNBDL, DBAC, MB, PC, SN	[G]
752-192	192 mm (7-9/16") CC	8-5/16"	10	BNBDL, DBAC, MB, PC, SN	[G]
752-224	224 mm (8 13/16") CC	9-9/16"	10	BNBDL, DBAC, MB, PC, SN	[H]

Finishes



BNBDL
Brushed Pewter



DBAC
Brushed Oil
Rubbed Bronze



MB
Matte Black



PC
Polished Chrome



SN
Satin Nickel

JEFFREY ALEXANDER®

by Hardware Resources





SUTTON

Item	Description	Overall Length or Diameter	Ctn Qty	Finishes	Price Code
635-32	32 mm (1-1/4") CC	2-1/4"	30	BG, BNBDL, DBAC, MB, NI, PC, SBZ, SN	[E]
635-96	96 mm (3-3/4") CC	4-3/4"	25	BG, BNBDL, DBAC, MB, NI, PC, SBZ, SN	[F]
635-128	128 mm (5-1/16") CC	5-7/8"	20	BG, BNBDL, DBAC, MB, NI, PC, SBZ, SN	[F]
635-160	160 mm (6-5/16") CC	7-1/2"	10	BG, BNBDL, DBAC, MB, NI, PC, SBZ, SN	[G]
635-256	256 mm (10-1/16") CC	11-7/16"	20	BG, BNBDL, DBAC, MB, NI, PC, SBZ, SN	[K]

Finishes



BG
Brushed
Gold

BNBDL
Brushed
Pewter

DBAC
Brushed Oil
Rubbed
Bronze

MB
Matte Black

NI
Polished
Nickel

PC
Polished
Chrome

SBZ
Satin Bronze

SN
Satin Nickel

JEFFREY ALEXANDER®

by Hardware Resources



TAHOE

US Patent # D602,330; D598,270

Item	Description	Overall Length or Diameter	Ctn Qty	Finishes	Price Code
602S	small knob	1-1/4"	30	BLK, DMAC, SIM	[G]
602	large knob	1-1/2"	25	BLK, DMAC, SIM	[G]
602-96	96 mm (3-3/4") CC	4-1/2"	10	BLK, DMAC, SIM	[H]
602-128	128 mm (5-1/16") CC	5-13/16"	10	BLK, DMAC, SIM	[J]
602-12	12" CC appliance pull	12-3/4"	5	BLK, DMAC, SIM	[K]

Finishes



BLK
Black



DMAC
Distressed Oil
Rubbed Bronze



SIM
Distressed Antique
Silver

JEFFREY ALEXANDER®

by Hardware Resources



TIFFANY

US Patent # D792,188

Item	Description	Overall Length or Diameter	Ctn Qty	Finishes	Price Code
658	knob	1-1/4"	20	BG, BNBDL, DBAC, NI, PC, SBZ, SN	[F]
658-96	96 mm (3-3/4") CC	4-1/2"	20	BG, BNBDL, DBAC, NI, PC, SBZ, SN	[G]
658-128	128 mm (5-1/16") CC	5-13/16"	15	BG, BNBDL, DBAC, NI, PC, SBZ, SN	[H]
658-160	160 mm (6-5/16") CC	7-1/16"	10	BG, BNBDL, DBAC, NI, PC, SBZ, SN	[J]
658-192	192 mm (7-9/16") CC	8-3/8"	15	BG, BNBDL, DBAC, NI, PC, SBZ, SN	[J]
658-224	224 mm (8-13/16") CC	9-7/8"	15	BG, BNBDL, DBAC, NI, PC, SBZ, SN	[K]
658-12	12" CC appliance pull	13"	5	BG, BNBDL, DBAC, NI, PC, SBZ, SN	[K]

Finishes



BG
Brushed Gold



BNBDL
Brushed Pewter



DBAC
Brushed Oil Rubbed Bronze



NI
Polished Nickel



PC
Polished Chrome



SBZ
Satin Bronze



SN
Satin Nickel

JEFFREY ALEXANDER®

by Hardware Resources



JEFFREY ALEXANDER®

by Hardware Resources



JEFFREY ALEXANDER®

by Hardware Resources



WHEELER

Item	Description	Overall Length or Diameter	Ctn Qty	Finishes	Price Code
678 NEW	knob	1-1/4"	20	BG, BNBDL, DBAC, MB, PC, SBZ, SN	[D]
678-96 NEW	96 mm (3-3/4") CC	5"	10	BG, BNBDL, DBAC, MB, PC, SBZ, SN	[F]
678-128 NEW	128 mm (5-1/16") CC	6-1/4"	10	BG, BNBDL, DBAC, MB, PC, SBZ, SN	[G]
678-160 NEW	160 mm (6-5/16") CC	7-1/2"	10	BG, BNBDL, DBAC, MB, PC, SBZ, SN	[G]
678-18 NEW	18" CC appliance pull	20-1/4"	5	BG, BNBDL, DBAC, MB, PC, SBZ, SN	[K]

Finishes



BG
Brushed Gold



BNBDL
Brushed
Pewter



DBAC
Brushed Oil
Rubbed Bronze



MB
Matte Black



PC
Polished
Chrome



SBZ
Satin Bronze



SN
Satin Nickel



ZANE

Item	Description	Overall Length or Diameter	Ctn Qty	Finishes	Price Code
293T	knob	2"	10	BNBDL, NI, PC, SN	[E]
293-96	96 mm (3-3/4") CC	5-1/16"	10	BNBDL, NI, PC, SN	[G]
293-128	128 mm (5-1/16") CC	6-5/16"	10	BNBDL, NI, PC, SN	[G]
293-160	160 mm (6-5/16") CC	7-9/16"	10	BNBDL, NI, PC, SN	[H]
293-192	192 mm (7-9/16") CC	8-13/16"	10	BNBDL, NI, PC, SN	[H]
293-224	224 mm (8-13/16") CC	10-1/16"	10	BNBDL, NI, PC, SN	[J]
293-305	305 mm (12") CC	13-1/4"	10	BNBDL, NI, PC, SN	[K]

Finishes



BNBDL
Brushed Pewter



NI
Polished Nickel



PC
Polished Chrome



SN
Satin Nickel

JEFFREY ALEXANDER®

by Hardware Resources





The **essentials** and more, priced right

Over 40 designs of knobs and pulls in the most popular styles and finishes

Complete line of steel bar pulls available in the Naples collection

Base metal of cast zinc alloy, steel, aluminum or stainless steel for durability

Machine polished for consistent quality

Also ideal for the commercial, multi-family, retail and builder markets

Lifetime Warranty



ASHER

Item	Description	Overall Length or Diameter	Ctn Qty	Finishes	Price Code
193-3	3" CC	3-1/4"	15	BC, BNBDL, DBAC, PC, SN	[D]
193-96	96 mm (3-3/4") CC	4"	15	BC, BNBDL, DBAC, PC, SN	[D]
193-4	4" CC	4-1/4"	15	BC, BNBDL, DBAC, PC, SN	[E]
193-128	128 mm (5-1/16") CC	5-1/4"	10	BC, BNBDL, DBAC, PC, SN	[E]
193-160	160 mm (6-5/16") CC	6-9/16"	10	BC, BNBDL, DBAC, PC, SN	[F]

Finishes



BC
Brushed Chrome



BNBDL
Brushed Pewter



DBAC
Brushed Oil
Rubbed Bronze



PC
Polished Chrome



SN
Satin Nickel

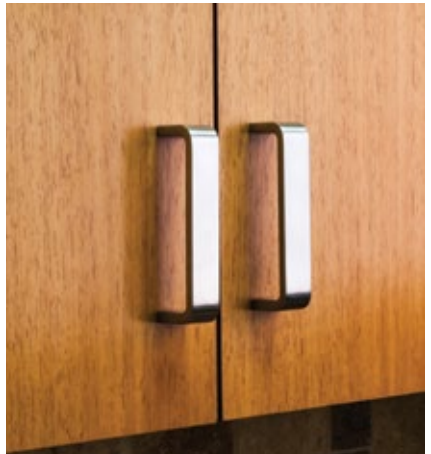





AIDEN

Item	Description	Overall Length or Diameter	Ctn Qty	Finishes	Price Code
993	knob	1-5/8"	30	BNBDL, DBAC, PC, SN	[B]
993-3	3" CC	4-1/16"	25	BNBDL, DBAC, PC, SN	[D]
993-96	96 mm (3-3/4") CC	4-3/4"	20	BNBDL, DBAC, PC, SN	[D]
993-128	128 mm (5-1/16") CC	6-1/8"	15	BNBDL, DBAC, PC, SN	[E]

Finishes



BNBDL
Brushed Pewter



DBAC
Brushed Oil
Rubbed Bronze



PC
Polished Chrome



SN
Satin Nickel



BELFAST

Item	Description	Overall Length or Diameter	Ctn Qty	Finishes	Price Code
308-128	128 mm (5-1/16") CC	5-9/16"	25	BLK, DN, PC, SN	[D]
406-128	128 mm (5-1/16") CC	6-9/16"	20	BLK, DN, PC, SN	[E]
745-128	128 mm (5-1/16") CC	5-11/16"	20	BLK, DN, PC, SN	[D]
776-128	128 mm (5-1/16") CC	5-11/16"	20	BLK, DN, PC, SN	[E]
976-128	128 mm (5-1/16") CC	6-3/16"	20	BLK, DN, PC, SN	[E]

Finishes

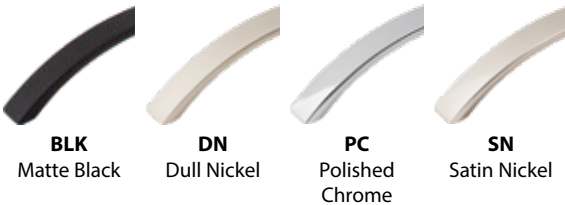



BRENTON

Item	Description	Overall Length or Diameter	Ctn Qty	Finishes	Price Code
239	knob	1"	30	BC, BNBDL, DACM, DBAC, PC, SN	[B]
239-96	96 mm (3-3/4") CC	4-5/16"	15	BC, BNBDL, DACM, DBAC, PC, SN	[D]
239-128	128 mm (5-1/16") CC	5-9/16"	15	BC, BNBDL, DACM, DBAC, PC, SN	[E]
239-160	160 mm (6-5/16") CC	6-13/16"	15	BC, BNBDL, DACM, DBAC, PC, SN	[F]
239-192	192 mm (7-9/16") CC	8-1/16"	10	BC, BNBDL, DACM, DBAC, PC, SN	[F]

Finishes





CALLOWAY

Item	Description	Overall Length or Diameter	Ctn Qty	Finishes	Price Code
331	small round knob	1-1/8"	25	BNBDL, DBAC, PC, SN	[B]
351	small square knob	1-1/8"	25	BNBDL, DBAC, PC, SN	[B]
331L	large round knob	1-1/4"	25	BNBDL, DBAC, PC, SN	[C]
351L	large square knob	1-1/4"	25	BNBDL, DBAC, PC, SN	[C]
331-96	96 mm (3-3/4") CC	4-1/2"	15	BNBDL, DBAC, PC, SN	[D]
351-96	96 mm (3-3/4") CC	4-7/16"	15	BNBDL, DBAC, PC, SN	[D]
331-128	128 mm (5-1/16") CC	5-3/4"	10	BNBDL, DBAC, PC, SN	[D]
351-128	128 mm (5-1/16") CC	5-11/16"	10	BNBDL, DBAC, PC, SN	[E]

Finishes





COSGROVE

Item		Overall Length or Diameter	Ctn Qty	Finishes	Price Code
382	knob	1-1/2"	25	BNBDL, DBAC, PC, SN	[B]
382-96	96 mm (3-3/4") CC	6-1/2"	15	BNBDL, DBAC, PC, SN	[E]
382-128	128 mm (5-1/16") CC	7-3/4"	10	BNBDL, DBAC, PC, SN	[F]
382-160	160 mm (6-5/16") CC	9"	10	BNBDL, DBAC, PC, SN	[F]

Finishes



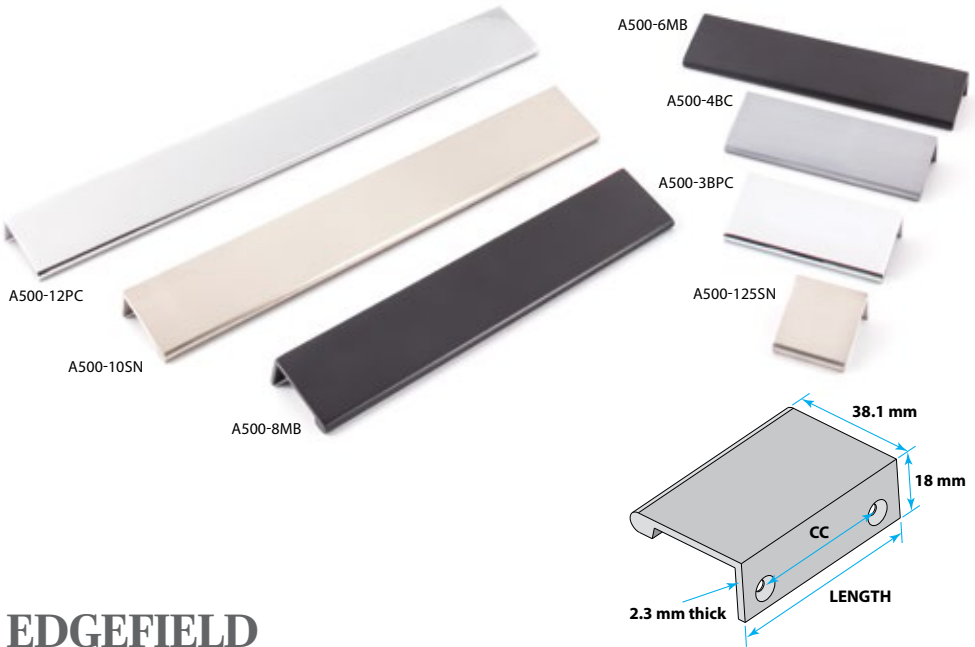

EDGEFIELD

Item	Description	Overall Length	Ctn Qty	Finishes	Price Code
A500-125*	16 mm (5/8") CC tab pull	1-1/4"	50	BC, MB, PC, SN	[B]
A500-3*	60 mm (2-3/8") CC tab pull	3"	25	BC, MB, PC, SN	[D]
A500-4*	76 mm (2-15/16") CC tab pull	4"	25	BC, MB, PC, SN	[D]
A500-6*	127 mm (5") CC tab pull	6"	20	BC, MB, PC, SN	[E]
A500-8*	90 mm (3-9/16") CC tab pull (3 holes)	8"	20	BC, MB, PC, SN	[F]
A500-10*	114 mm (4-1/2") CC tab pull (3 holes)	10"	10	BC, MB, PC, SN	[G]
A500-12*	90 mm (3-9/16") CC tab pull (4 holes)	12"	50	BC, MB, PC, SN	[H]

*Wood screws included with all tab pulls

Finishes

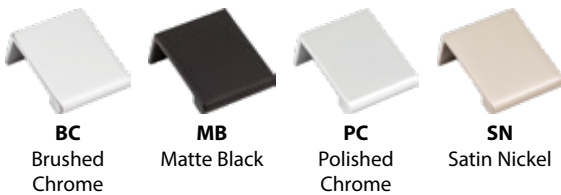



FLORENCE

Item	Description	Overall Length or Diameter	Ctn Qty	Finishes	Price Code
2980	knob	1-1/4"	20	AB, BNBDL, DACM, DBAC, MB, ORB, PC, SBZ, SN	[C]
2981	3" CC cup pull	3-11/16"	20	AB, BNBDL, DACM, DBAC, MB, ORB, PC, SBZ, SN	[D]

Finishes



AB
Brushed
Antique Brass



BNBDL
Brushed Pewter



DACM
Gun Metal



DBAC
Brushed Oil
Rubbed Bronze



MB
Matte Black



ORB
Dark Bronze



PC
Polished Chrome



SBZ
Satin Bronze



SN
Satin Nickel



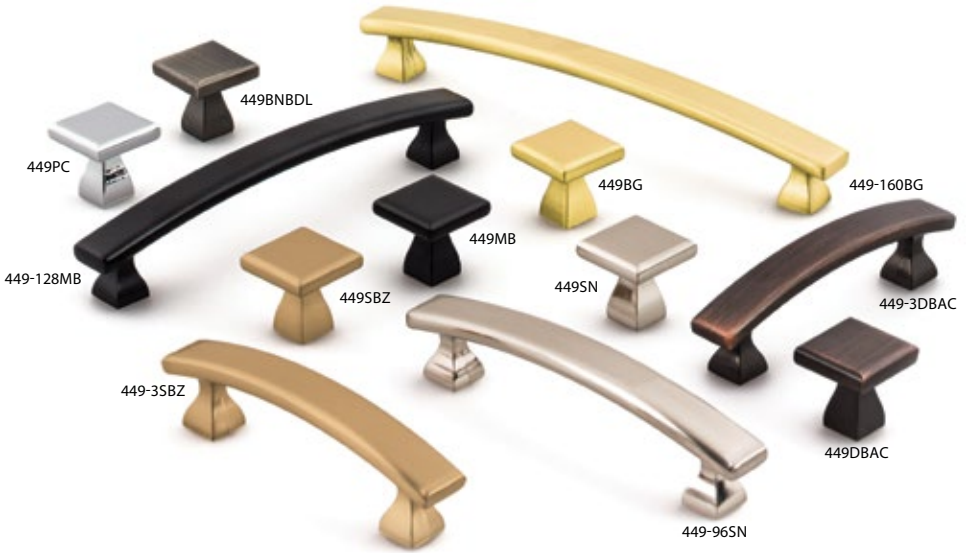

HADLY *NEW ADDITIONS!*

US Patent # D833,249; D833,252

Item	Description	Overall Length or Diameter	Inner Box	Finishes	Price Code
449	knob	1"	25	BG, BNBDL, DBAC, MB, PC, SBZ, SN	[C]
449-3	3" CC	4"	15	BG, BNBDL, DBAC, MB, PC, SBZ, SN	[D]
449-96	96 mm (3-3/4") CC	4-3/4"	15	BG, BNBDL, DBAC, MB, PC, SBZ, SN	[D]
449-128 <i>NEW</i>	128 mm (5-1/16") CC	6-1/16"	10	BG, BNBDL, DBAC, MB, PC, SBZ, SN	[E]
449-160 <i>NEW</i>	160 mm (6-5/16") CC	7-5/16"	10	BG, BNBDL, DBAC, MB, PC, SBZ, SN	[F]

Finishes



BG *NEW*
Brushed Gold



BNBDL
Brushed Pewter



DBAC
Brushed Oil
Rubbed Bronze



MB *NEW*
Matte Black

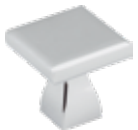

PC
Polished Chrome



SBZ *NEW*
Satin Bronze



SN
Satin Nickel





GLENDALE

Item	Description	Overall Length or Diameter	Ctn Qty	Finishes	Price Code
525	knob	1-1/8"	50	ABM-D, BNBDL, DBAC, DMAC, MB, PC, SIM, SBZ, SN	[C]
525-96	96 mm (3-3/4") CC	4-15/16"	25	ABM-D, BNBDL, DBAC, DMAC, MB, PC, SIM, SBZ, SN	[D]

Finishes



ABM-D
Distressed
Antique Brass

BNBDL
Brushed
Pewter

DBAC
Brushed
Oil Rubbed
Bronze

DMAC
Distressed
Oil Rubbed
Bronze

MB
Matte Black



PC
Polished
Chrome

SIM
Distressed
Antique Silver

SBZ
Satin Bronze

SN
Satin Nickel

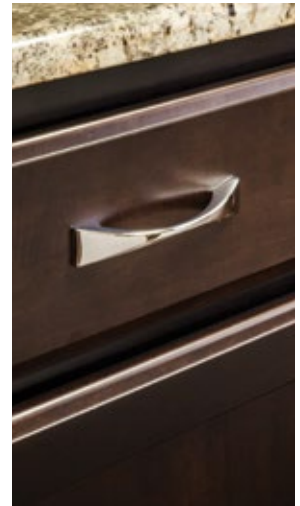



KENNER

Item	Description	Overall Length or Diameter	Ctn Qty	Finishes	Price Code
3970	knob	1-1/8"	25	BNBDL, DBAC, PC, SN	[A]
254-3	3" CC	5"	20	BNBDL, DBAC, PC, SN	[B]
254-96	96 mm (3-3/4") CC	5-3/4"	20	BNBDL, DBAC, PC, SN	[D]

Finishes







KNOX **NEW!**

Item	Description	Overall Length or Diameter	Ctn Qty	Finishes	Price Code
645-96 NEW	96 mm (3-3/4") CC	4-1/4"	10	MB, PC, SN	[E]
645-128 NEW	128 mm (5-1/16") CC	5-9/16"	10	MB, PC, SN	[F]
645-160 NEW	160 mm (6-5/16")	6-13/16"	10	MB, PC, SN	[F]
645-192 NEW	192 mm (7-9/16")	8-1/16"	10	MB, PC, SN	[G]
645-224 NEW	224 mm (8-13/16")	9-5/16"	10	MB, PC, SN	[G]
645-320 NEW	320 mm (12-5/8") CC	13-1/16"	10	MB, PC, SN	[H]

Finishes



MB
Matte Black



PC
Polished Chrome



SN
Satin Nickel



LINDOS

Item	Description	Overall Length or Diameter	Ctn Qty	Finishes	Price Code
Z115	round knob	1-1/4"	25	BNBDL, DBAC, PC, SN	[B]
Z115L	oblong knob	1-3/8"	25	BNBDL, DBAC, PC, SN	[B]
Z115-96	96 mm (3-3/4") CC	4-3/8"	20	BNBDL, DBAC, PC, SN	[C]
Z115-128	128 mm (5-1/16") CC	5-9/16"	15	BNBDL, DBAC, PC, SN	[G]

Finishes





MADISON

Item	Description	Overall Length or Diameter	Ctn Qty	Finishes	Price Code
3910	knob	1-3/16"	30	AB, ALM, BC, BG, BN, BNBDL, DACM, DBAC, MB, ORB, PB, PC, SB, SBZ, SN, WH	[B]
Z259-3	3" CC	3-3/8"	50	AB, BC, BN, BNBDL, DACM, DBAC, MB, ORB, PB, PC, SB, SBZ, SSN	[B]
Z259-12	12" CC appliance pull	13"	5	AB, BC, BN, DACM, DBAC, ORB, PC, SN	[K]

Finishes



AB
Brushed
Antique
Brass



ALM
Almond



BC
Brushed
Chrome



BG
Brushed
Gold



BN
Black Nickel



BNBDL
Brushed
Pewter



DACM
Gun Metal



DBAC
Brushed
Oil Rubbed
Bronze



MB
Matte
Black



ORB
Dark
Bronze



PB
Polished
Brass



PC
Polished
Chrome



SB
Satin
Brass



SBZ
Satin
Bronze



SN
Satin
Nickel



WH
White



MERRYVILLE

Item	Description	Overall Length or Diameter	Ctn Qty	Finishes	Price Code
897	small egg knob	1-1/8"	20	BNBDL, DBAC, PC, SN	[B]
897L	large egg knob	1-1/4"	20	BNBDL, DBAC, PC, SN	[B]
897-3	3" CC	5-1/8"	20	BNBDL, DBAC, PC, SN	[B]

Finishes

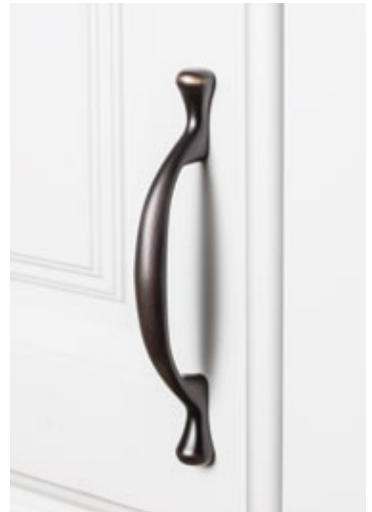
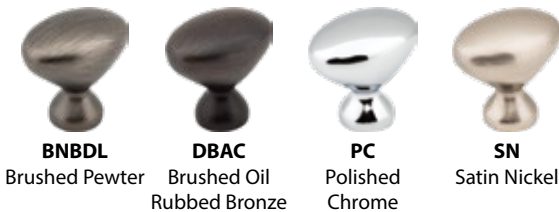

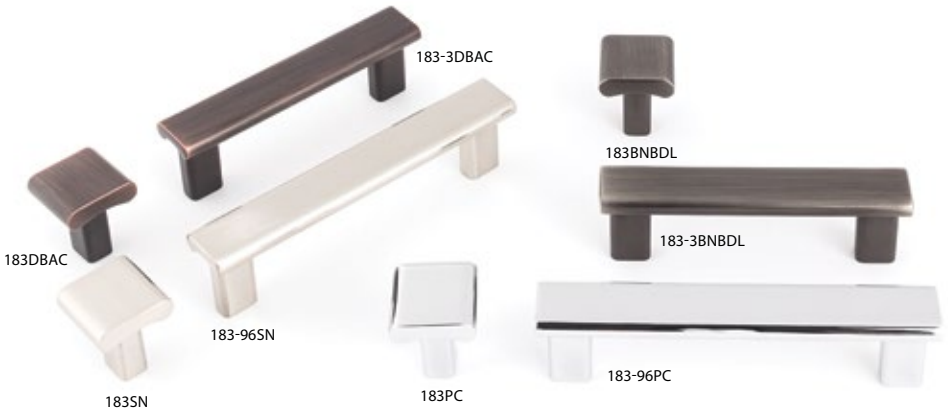

PARK

US Patent # D833,250; D833,253

Item	Description	Overall Length or Diameter	Ctn Qty	Finishes	Price Code
183	knob	1"	25	BNBDL, DBAC, PC, SN	[C]
183-3	3" CC	3-3/4"	15	BNBDL, DBAC, PC, SN	[D]
183-96	96 mm (3-3/4") CC	4-1/2"	15	BNBDL, DBAC, PC, SN	[D]

Finishes



BNBDL
Brushed Pewter



DBAC
Brushed Oil Rubbed Bronze



PC
Polished Chrome



SN
Satin Nickel





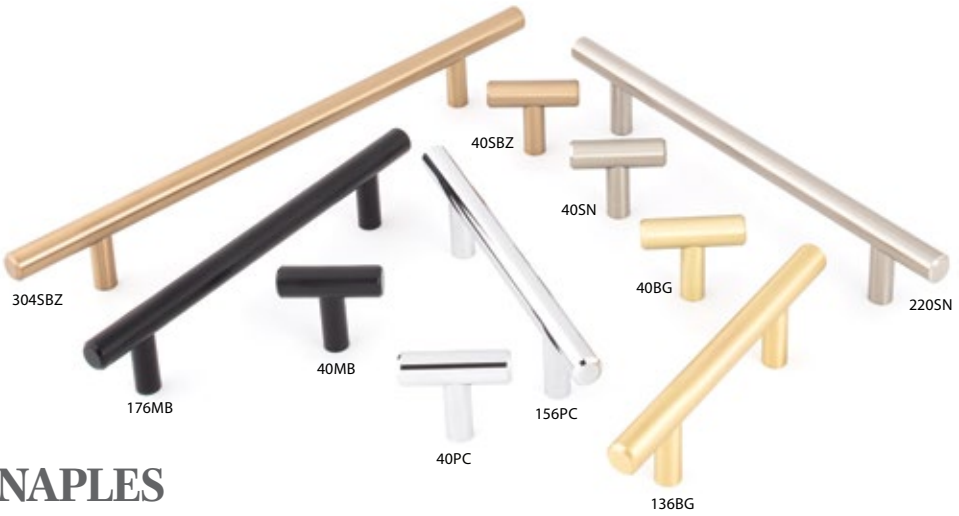

NAPLES

Item	Description	Overall Length or Diameter	Ctn Qty	Material	Finishes	Price Code
40	T knob	1-9/16"	30	Steel	BG, MB, PC, SBZ, SN	[B]
136	3" CC	5-3/8"	10	Steel	BG, MB, PC, SBZ, SN	[C]
156	96 mm (3-3/4") CC	6-1/8"	10	Steel	BG, MB, PC, SBZ, SN	[D]
176	128 mm (5-1/16") CC	6-15/16"	10	Steel	BG, MB, PC, SBZ, SN	[D]
206	128 mm (5-1/16") CC	8-1/8"	10	Steel	BG, MB, PC, SBZ, SN	[E]
220	160 mm (6-5/16") CC	8-11/16"	10	Steel	BG, MB, PC, SBZ, SN	[E]
272	192 mm (7-9/16") CC	10-11/16"	10	Steel	BG, MB, PC, SBZ, SN	[E]
304	224 mm (8-13/16") CC	11-15/16"	10	Steel	BG, MB, PC, SBZ, SN	[F]
336	256 mm (10-1/16") CC	13-1/4"	10	Steel	BG, MB, PC, SBZ, SN	[F]
368	288 mm (11-5/16") CC	14-1/2"	10	Steel	BG, MB, PC, SBZ, SN	[F]
399	319 mm (12-9/16") CC	15-11/16"	10	Steel	BG, MB, PC, SBZ, SN	[G]
496	416 mm (16-1/2") CC	19-1/2"	10	Steel	BG, MB, PC, SBZ, SN	[G]
560	480 mm (18-7/8") CC	22-1/16"	10	Steel	PC, SN	[H]
624	544 mm (21-7/16") CC	24-9/16"	10	Steel	PC, SN	[H]
720	640 mm (25-3/16") CC	28-3/8"	10	Steel	PC, SN	[J]
763	673 mm (26-1/2") CC	30-1/16"	10	Steel	PC, SN	[J]

Finishes



BG
Brushed Gold



MB
Matte Black



PC
Polished Chrome



SBZ
Satin Bronze



SN
Satin Nickel

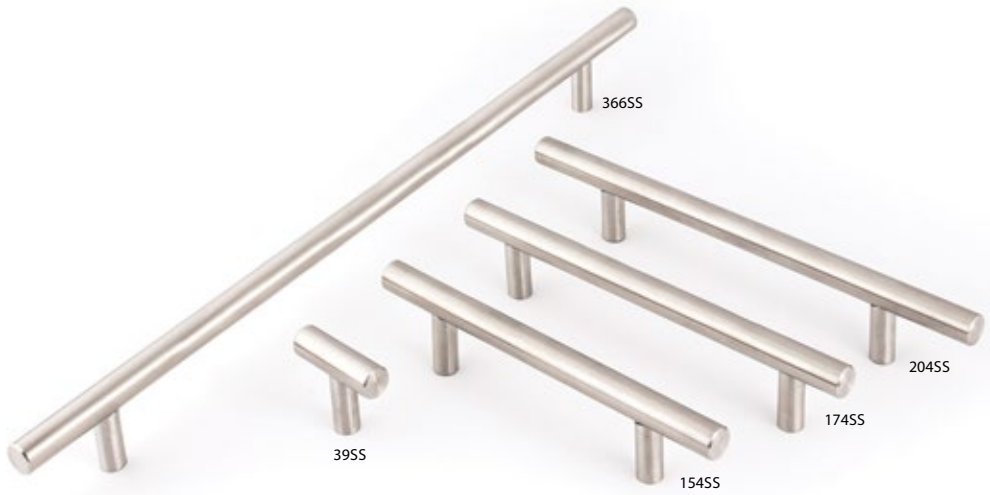

NAPLES – STAINLESS STEEL

Item	Description	Overall Length or Diameter	Ctn Qty	Material	Finishes	Price Code
39	T knob	1-1/2"	40	Hollow Stainless Steel	SS	[A]
154	96 mm (3-3/4") CC	6-1/16"	20	Hollow Stainless Steel	SS	[C]
174	128 mm (5-1/16") CC	6-7/8"	20	Hollow Stainless Steel	SS	[D]
204	128 mm (5-1/16") CC	8"	20	Hollow Stainless Steel	SS	[E]
270	192 mm (7-9/16") CC	10-5/8"	20	Hollow Stainless Steel	SS	[E]
302	224 mm (8-13/16") CC	11-7/8"	20	Hollow Stainless Steel	SS	[E]
334	256 mm (10-1/16") CC	13-1/8"	20	Hollow Stainless Steel	SS	[F]
366	288 mm (11-5/16") CC	14-7/16"	10	Hollow Stainless Steel	SS	[F]
397	319 mm (12-9/16") CC	15-5/8"	10	Hollow Stainless Steel	SS	[F]
494	416 mm (16-1/2") CC	19-7/16"	10	Hollow Stainless Steel	SS	[G]
558	480 mm (18-7/8") CC	22"	10	Hollow Stainless Steel	SS	[G]
622	544 mm (21-7/16") CC	24-1/2"	10	Hollow Stainless Steel	SS	[H]
719	640 mm (25-3/16") CC	28-5/16"	10	Hollow Stainless Steel	SS	[H]
761	673 mm (26-1/2") CC	29-15/16"	10	Hollow Stainless Steel	SS	[H]



SEAVER

Item	Description	Overall Length or Diameter	Ctn Qty	Finishes	Price Code
511	knob	1-1/4"	25	BNBDL, DBAC, PC, SN	[B]
511-3	3" CC	4-1/16"	15	BNBDL, DBAC, PC, SN	[D]
511-96	96 mm (3-3/4") CC	4-7/8"	15	BNBDL, DBAC, PC, SN	[D]

Finishes

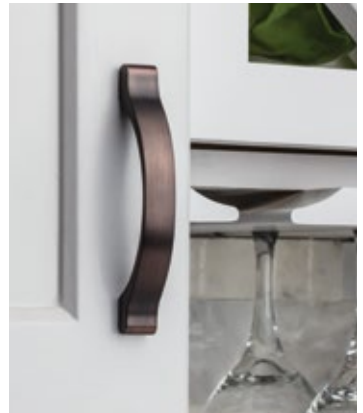



SEDONA

Item	Description	Overall Length or Diameter	Ctn Qty	Finishes	Price Code
26	knob	1"	30	SN	[B]
400	3" CC	4"	10	SN	[D]
475	96 mm (3-3/4") CC	4-3/4"	10	SN	[E]
600	128 mm (5-1/16") CC	6"	10	SN	[F]

Finishes



SN
Satin Nickel





SLADE

Item	Description	Overall Length or Diameter	Ctn Qty	Finishes	Price Code
3915	knob	1"	50	BNBDL, DACM, DBAC, PC, SN	[A]
984-3	3" CC	3-1/2"	30	BNBDL, DACM, DBAC, PC, SN	[C]
984-96	96 mm (3-3/4") CC	4-1/4"	25	BNBDL, DACM, DBAC, PC, SN	[C]
984-128	128 mm (5") CC	5-1/2"	25	BNBDL, DACM, DBAC, PC, SN	[D]
984-160	160 mm (6-5/16") CC	6-3/4"	15	BNBDL, DACM, DBAC, PC, SN	[D]
984-192	192 mm (7-9/16") CC	8"	15	BNBDL, DACM, DBAC, PC, SN	[E]

Finishes







STANTON

Item	Description	Overall Length or Diameter	Ctn Qty	Finishes	Price Code
625-3	3" CC	3-3/8"	20	BG, MB, MS, PC, SBZ, SN	[D]
625-96	96 mm (3-3/4") CC	4-1/8"	25	BG, MB, MS, PC, SBZ, SN	[E]
625-128	128 mm (5-1/16") CC	5-3/8"	20	BG, MB, MS, PC, SBZ, SN	[E]
625-160	160 mm (6-5/16") CC	6-5/8"	10	BG, MB, MS, PC, SBZ, SN	[F]
625-192	192 mm (7-9/16") CC	7-15/16"	10	BG, MB, MS, PC, SBZ, SN	[F]
625-224	224 mm (8-13/16") CC	9-3/16"	10	BG, MB, MS, PC, SBZ, SN	[G]
625-320	320 mm (12-5/8") CC	12-15/16"	10	BG, MB, MS, PC, SBZ, SN	[H]
625-448	448 mm (17-5/8") CC	18"	10	BG, MB, MS, PC, SBZ, SN	[J]

Finishes



BG
Brushed Gold



MB
Matte Black



MS
Matte Silver



PC
Polished Chrome



SBZ
Satin Bronze



SN
Satin Nickel



STRICKLAND

Item	Description	Overall Length or Diameter	Ctn Qty	Finishes	Price Code
771-3	3" CC	4-1/2"	20	BNBDL, DBAC, PC, SN	[D]
771-96	96 mm (3-3/4") CC	5-3/16"	20	BNBDL, DBAC, PC, SN	[D]
771-128	128 mm (5-1/16") CC	6-5/16"	20	BNBDL, DBAC, PC, SN	[E]
771-160	160 mm (6-5/16") CC	7-11/16"	20	BNBDL, DBAC, PC, SN	[F]

Finishes



BNBDL
Brushed Pewter



DBAC
Brushed Oil
Rubbed Bronze



PC
Polished Chrome



SN
Satin Nickel





WATERVALE

Item	Description	Overall Length or Diameter	Ctn Qty	Finishes	Price Code
647	knob	1-1/8"	20	BNBDL, DBAC, PC, SN	[A]
647-3	3" CC	4-5/8"	15	BNBDL, DBAC, PC, SN	[B]
647-96	96 mm (3-3/4") CC	5-3/8"	20	BNBDL, DBAC, PC, SN	[D]

Finishes



BNBDL
Brushed Pewter



DBAC
Brushed Oil
Rubbed Bronze



PC
Polished
Chrome



SN
Satin Nickel







THATCHER *NEW!*

Item	Description	Overall Length or Diameter	Ctn Qty	Finishes	Price Code
859T <i>NEW</i>	knob	1-1/2"	25	BG, BNBDL, DBAC, MB, PC, SBZ, SN	[B]
859-3 <i>NEW</i>	3" CC	5-1/4"	25	BG, BNBDL, DBAC, MB, PC, SBZ, SN	[C]
859-96 <i>NEW</i>	96 mm (3-3/4") CC	6"	25	BG, BNBDL, DBAC, MB, PC, SBZ, SN	[C]
859-128 <i>NEW</i>	128 mm (5-1/16") CC	7-1/4"	25	BG, BNBDL, DBAC, MB, PC, SBZ, SN	[D]
859-160 <i>NEW</i>	160 mm (6-5/16") CC	8-1/2"	25	BG, BNBDL, DBAC, MB, PC, SBZ, SN	[E]

Finishes



BG

Brushed Gold



BNBDL

Brushed Pewter



DBAC

Brushed Oil Rubbed Bronze



MB

Matte Black



PC

Polished Chrome



SBZ

Satin Bronze



SN

Satin Nickel



WESTBURY

Item	Description	Overall Length or Diameter	Ctn Qty	Finishes	Price Code
3898	knob	1-1/4"	20	BNBDL, DBAC, PC, SN	[C]
3899	3" CC	5-1/8"	25	BNBDL, DBAC, PC, SN	[B]

Finishes





ZACHARY

Item	Description	Overall Length or Diameter	Ctn Qty	Finishes	Price Code
988	knob	1-1/16"	25	BNBDL, DBAC, PC, SN	[A]
988-3	3" CC	3-3/4"	20	BNBDL, DBAC, PC, SN	[B]
988-96	96 mm (3-3/4") CC	4-1/2"	20	BNBDL, DBAC, PC, SN	[D]
988-128	128 mm (5-1/16") CC	5-3/4"	25	BNBDL, DBAC, PC, SN	[D]
988-160	160 mm (6-5/16") CC	7-1/16"	10	BNBDL, DBAC, PC, SN	[E]

Finishes



AVAILABLE FINISHES

	AB Brushed Antique Brass		BNB Brushed Black Nickel		ORB Dark Bronze
	ABM/ABM-D Distressed Antique Brass		BNBDL Brushed Pewter		PB Polished Brass
	ABSB Antique Brushed Satin Brass		BNMDL/BNDL Distressed Pewter		PC Polished Chrome
	AE Antique Brass		BLK Black (Tahoe only)		SB Satin Brass
	AEM Lightly Distressed Antique Brass		DACM Gun Metal		SBZ Satin Bronze
	AL Aluminum		DBAC Brushed Oil Rubbed Bronze		SBN Satin Black Nickel
	ALM Almond		DP Distressed Pewter		SIM/SIM-D Distressed Antique Silver
	ASM Distressed Antique Silver		DMAC Distressed Oil Rubbed Bronze		SN Satin Nickel
	BB Brushed Brass		DN Dull Nickel		SS Stainless Steel
	BC Brushed Chrome		MB/BLK Matte Black		WH White
	BG Brushed Gold		MS Matte Silver		
	BN Black Nickel		NI Polished Nickel		

All brushed and machined finishes are created by hand to add texture to the item. We hold a tight range of acceptance of color variation, however, a slight variance in the texture and tone of these items occur. We consider these variances to be minimal; slight variations are normal.

